

# OPT7<sup>®</sup>

## RGBW BLUETOOTH HEADLIGHTS

2015-2017 FORD F-150

### INSTALLATION MANUAL

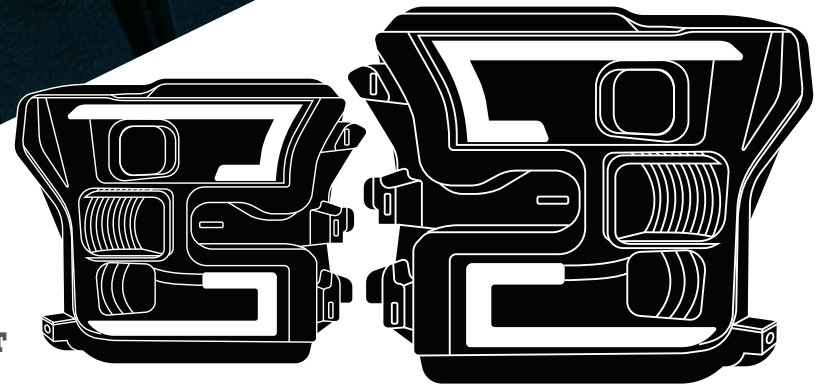

**x2**  
HEADLIGHT  
HOUSINGS

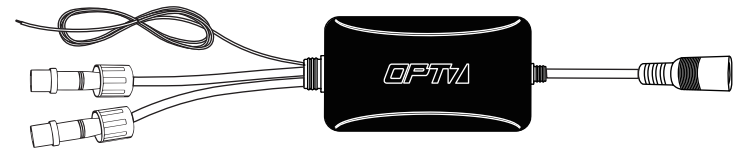

**x1**  
BLUETOOTH  
CONTROL BOX



**x1**  
10FT EXTENSION  
CABLE

### COMPONENTS

## TOOLS NEEDED

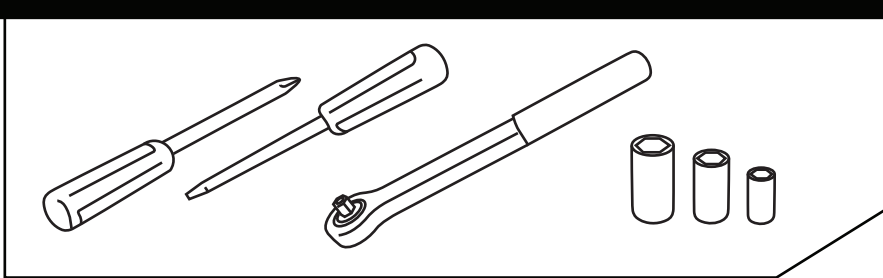

- SCREWDRIVERS (+ AND -)
- SOCKET WRENCH
- SOCKETS

### STEP 1

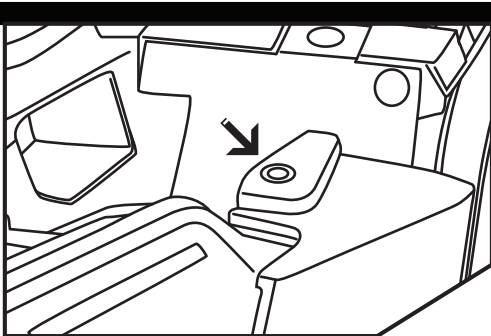

Remove the 2 plastic pop clips holding the trim in.

### STEP 3

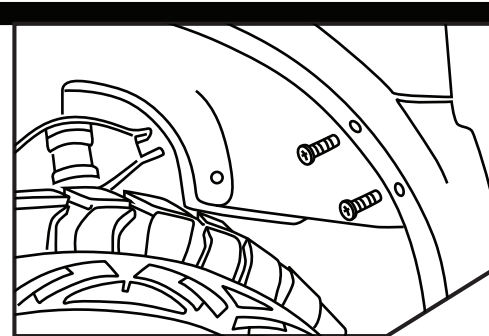

Remove the 2 bolts in the wheel well.

### STEP 2

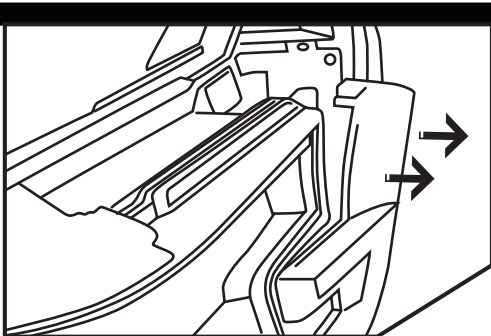

Release the trim piece.

### STEP 4

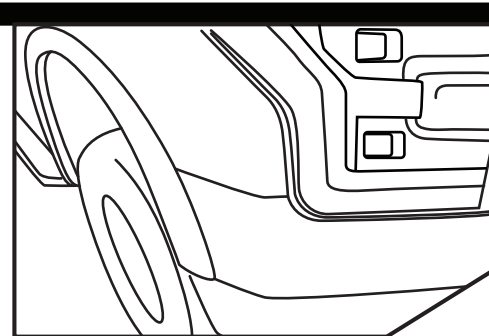

Remove the wheel arch trim by away from the vehicle.

## STEP 5

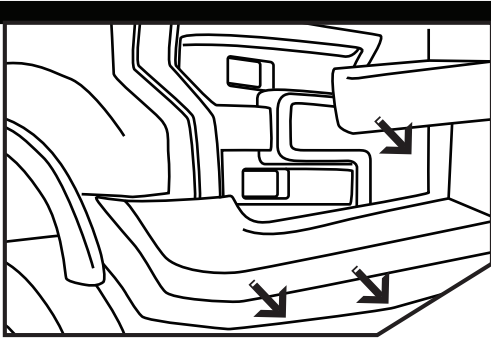

Remove the trim by pulling away from the vehicle.

## STEP 8

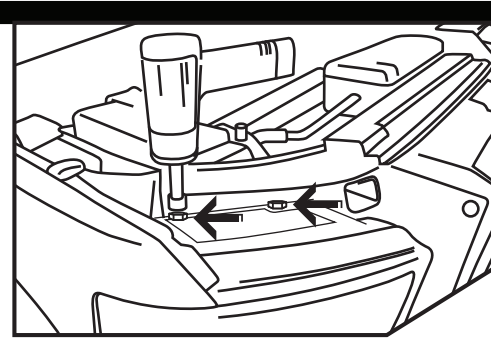

Remove the two bolts on top of the headlight housing using the screwdriver.

## STEP 6

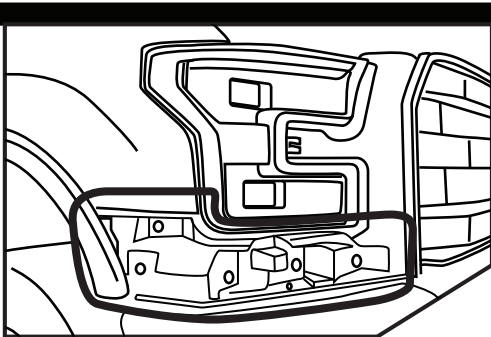

Remove the bolts holding the plastic reinforcement.

## STEP 9

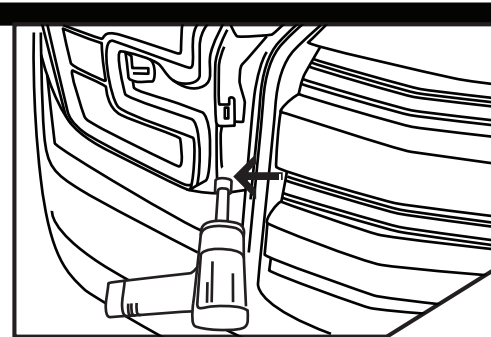

Remove the final bolt to release the headlight housing.

## STEP 7

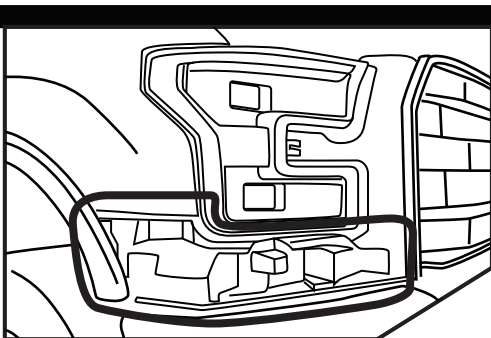

Ensure the plastic reinforcement is loose, it is not required to remove the part from the vehicle as a whole unless needed.

## STEP 10

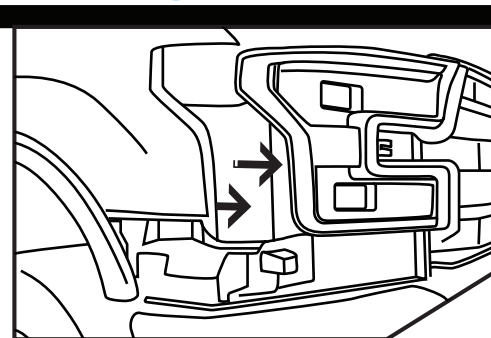

Pull the front of the projector headlight towards you to remove the headlight housing from the vehicle.

## STEP 11

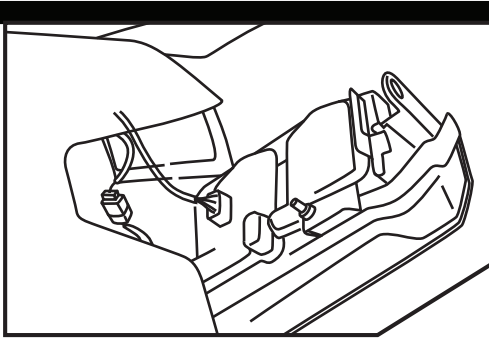

Unplug the electrical harness from the back of the headlight housing.

## STEP 12

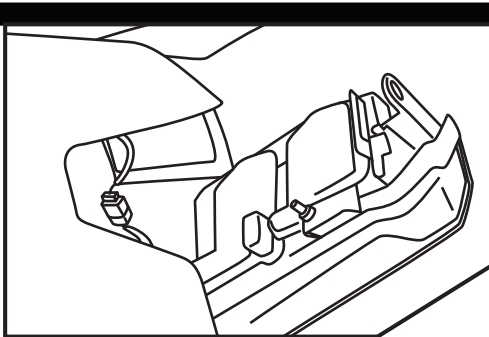

Remove headlight housing.

## STEP 13

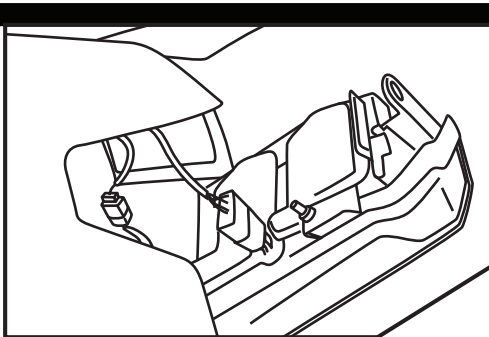

Install new headlight housing by connecting the electrical harness.

Black and Green Wires: Not needed a connection for DRL Tube to function. Ensure the wires are tied up securely to ensure wires are organized and store away from any metal surface.

## STEP 14

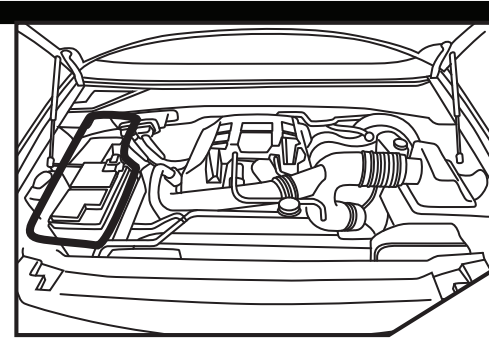

Install the Aura Control Box by connecting the positive wire for a constant on functionality (always on when battery is on) or an accessory wire (only on when the vehicle is on) which can be found in the Fuse Box. Connect the negative wire to a ground wire.

## STEP 15

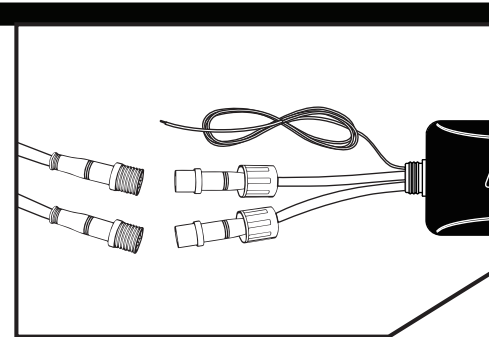

Connect the round connector from the headlight housings to the control box.

## STEP 16

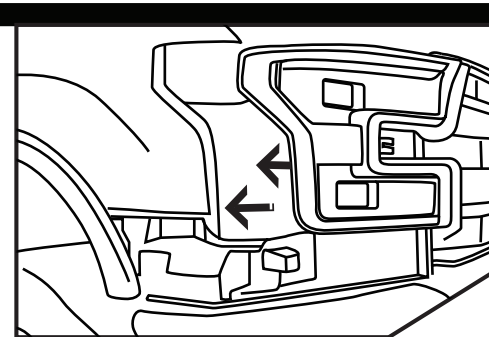

Replace the headlight housing by lining up the tabs and locking it into place.



## STEP 17

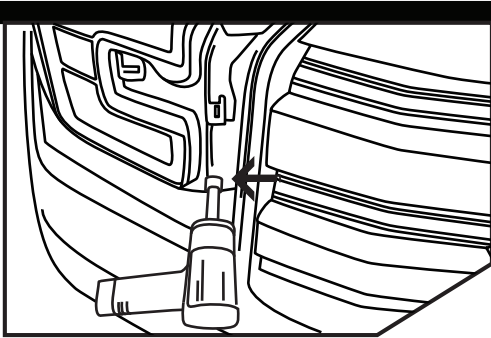

Replace the bolt to secure the headlight.

## STEP 20

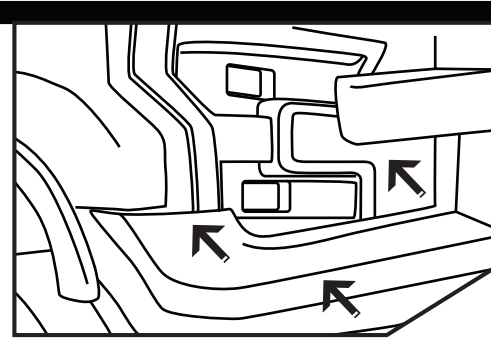

Replace the vehicle trim.

## STEP 18

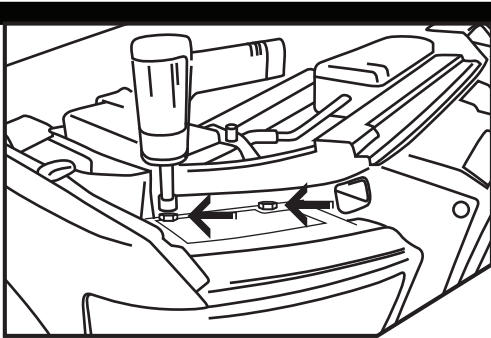

Replace the two bolts on top to secure the headlight housing.

## STEP 21

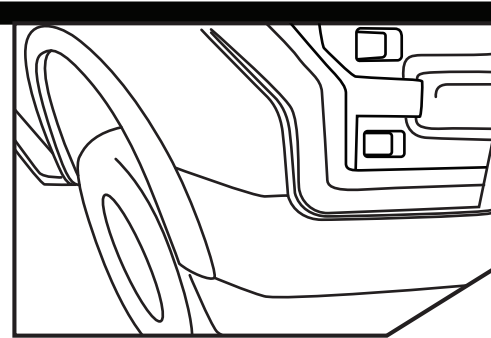

Re-attach the wheel arch trim.

## STEP 19

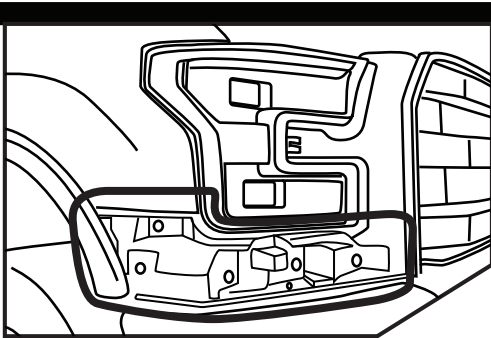

Replace the bolts to secure the plastic reinforcement.

## STEP 22

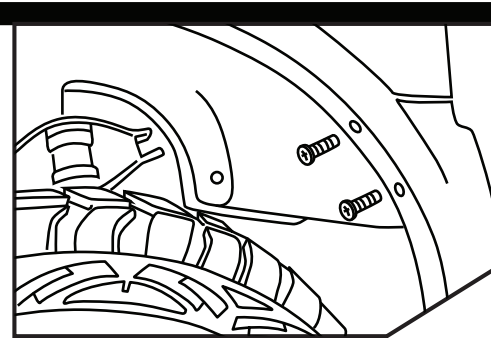

Replace the 2 bolts securing the trim.

## STEP 23

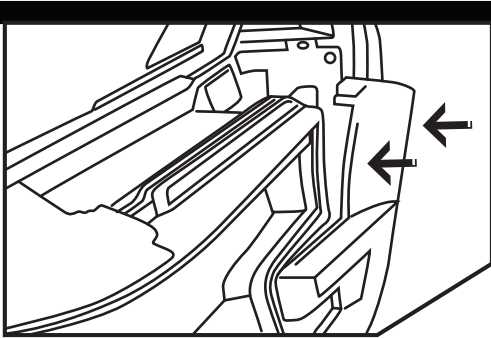

Push the trim into place.

## STEP 24

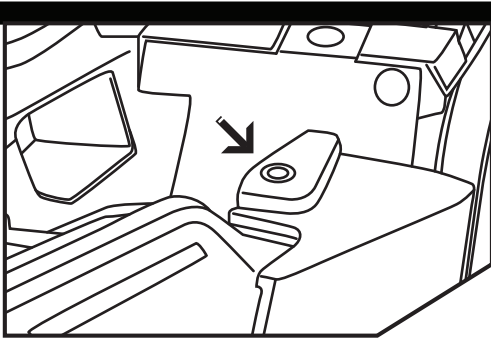

Secure the trim by inserting the plastic clip and locking into place.

## STEP 25

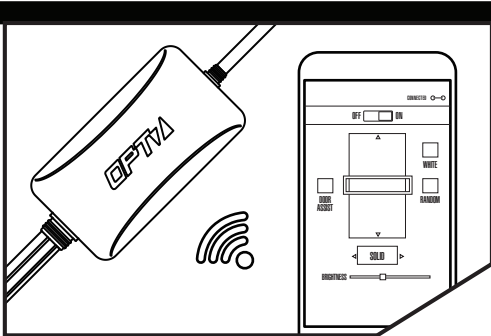

Test out your headlights using the AURA App.

# DISCLAIMER

[WWW.OPT-7.COM](http://WWW.OPT-7.COM)



OPT7 Lighting is not liable for damages or personal injuries while installing this product. The Installation Guide is intended as assistance to reduce setup time. OPT7 Lighting assumes no responsibility for improper installation.

If you are unfamiliar with your vehicle or inexperienced with aftermarket upgrades, please seek professional assistance.

## NEED SUPPORT?



Access our Knowledge Base by scanning the **QR code**, or visit [www.opt-7.com/support](http://www.opt-7.com/support)