



INSTALLATION GUIDE

2009-2016 Dodge Ram 1500

2010-2016 Dodge Ram 2500/3500

Tool required :

- 10mm socket
- Ratchet
- Panel Popper



If you are unfamiliar with your vehicle or inexperienced with aftermarket upgrades, professional installation is highly recommended.

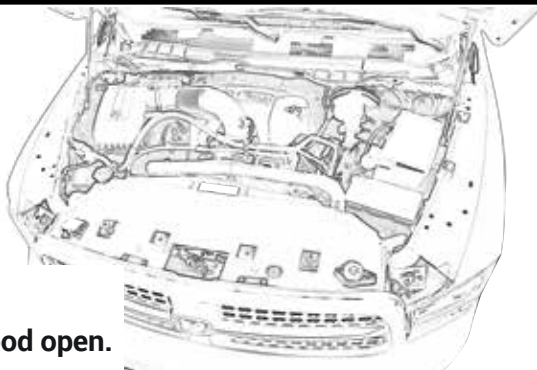

Step 1

Pop the hood open.



Step 2

Remove the plastic retainers securing the filler panel – there should be 6 in total.

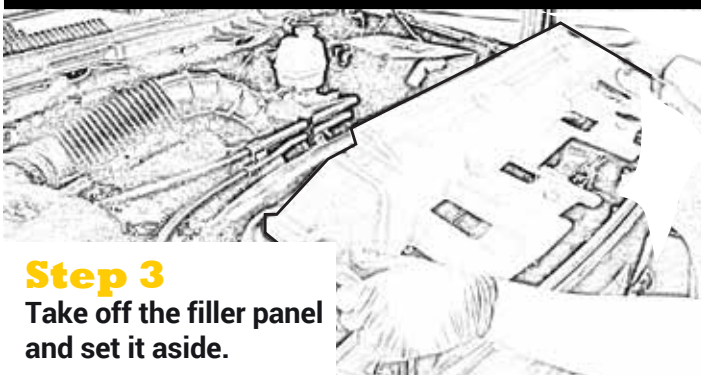

Step 3

Take off the filler panel and set it aside.

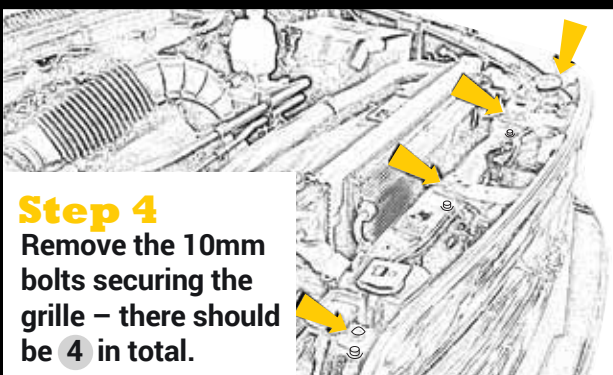

Step 4

Remove the 10mm bolts securing the grille – there should be 4 in total.

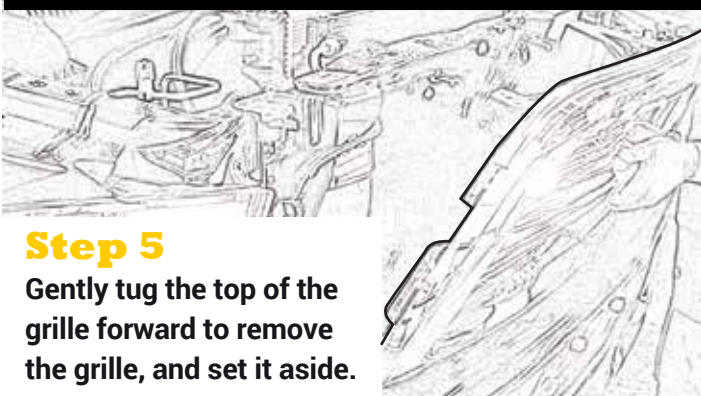

Step 5

Gently tug the top of the grille forward to remove the grille, and set it aside.

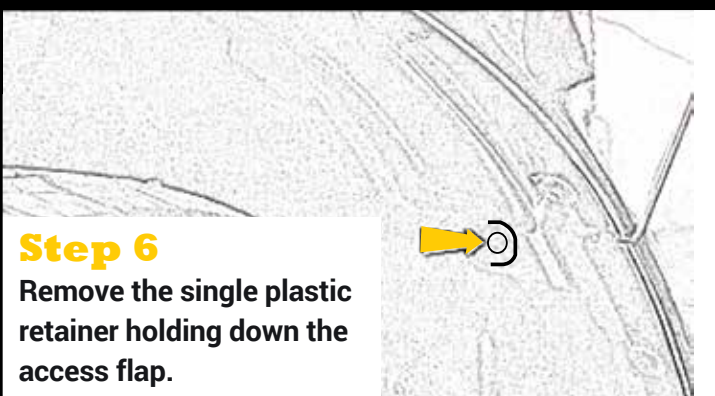

Step 6

Remove the single plastic retainer holding down the access flap.

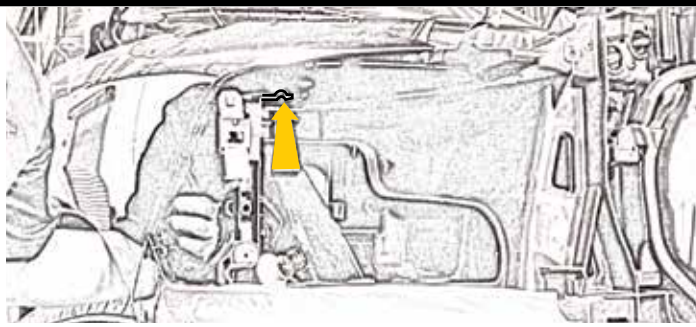
**Step 7**

Push upwards on the white retainer tab inside the access flap to unlock the stock headlight. (Illustration shows headlight removed.)

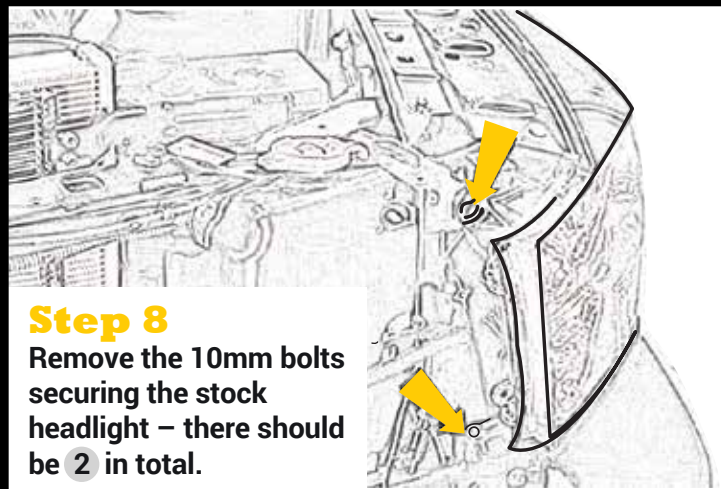
**Step 8**

Remove the 10mm bolts securing the stock headlight – there should be 2 in total.

**Step 9**

Pull the stock headlight outwards from the vehicle, and remove the turn signal socket from the headlight. (Warning: Do not let bare skin come in contact with exposed bulbs.)

**Step 10**

Unlock the red tab, and disconnect the headlight harness.

**Step 11**

Remove the high beam bulb from the stock headlight. (Warning: Do not let bare skin come in contact with exposed bulbs.)

**Step 12**

Place the high beam bulb into the REX headlight and connect it to the high beam harness. Replace the high beam cover seal when done.

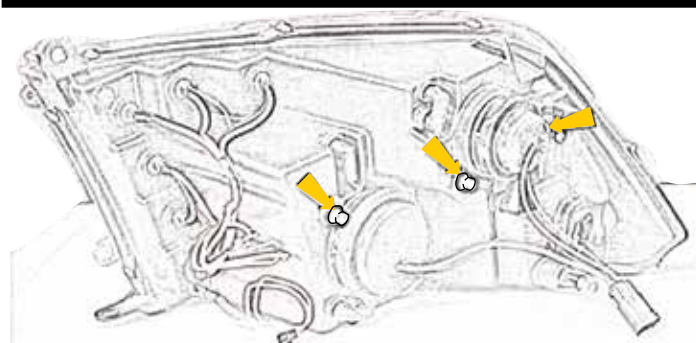
**Step 13**

(Illustration shows the 8mm beam adjusters on your REX headlight.)

**Step 14**

Place the turn signal socket back into the REX headlight.

**Step 15**

Reconnect the headlight harness.

**Step 16**

Seat the REX headlight.

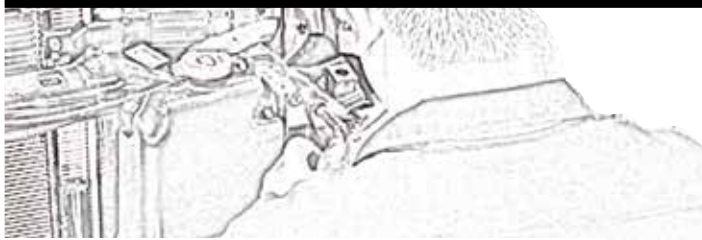
**Step 17**

Reinstall the 10mm bolts to secure the REX headlight – there should be 2 in total.

**Step 18**

Reach into the access flap to relock the headlight retainer tab.

**Step 19**

Shut the access flap and secure with the single plastic retainer.

**Step 20**

Reseat the grille.

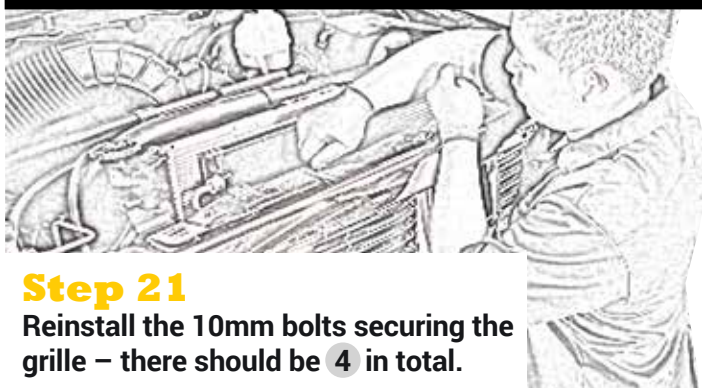
**Step 21**

Reinstall the 10mm bolts securing the grille – there should be 4 in total.

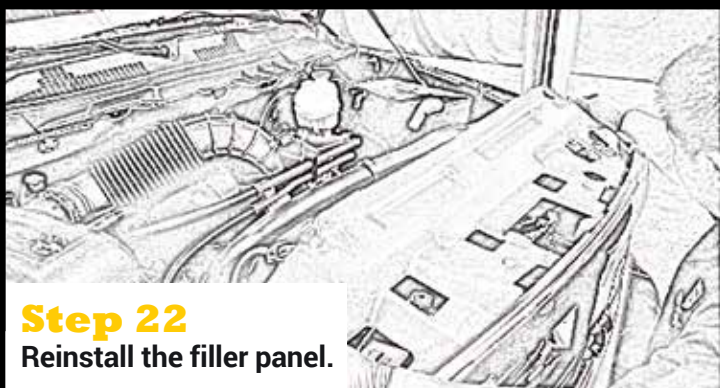
**Step 22**

Reinstall the filler panel.

**Step 23**

Reinstall the plastic retainers securing the filler panel – there should be 6 in total.

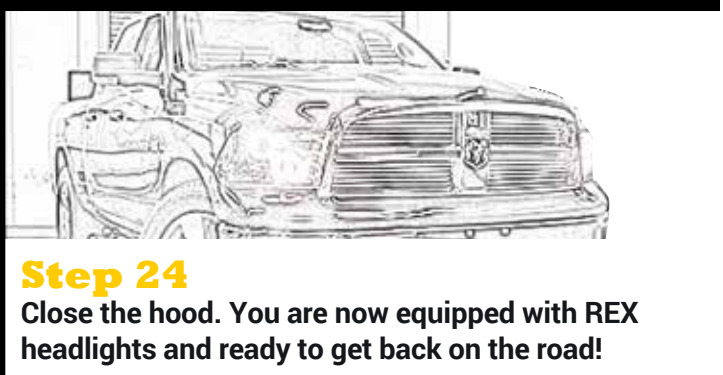
**Step 24**

Close the hood. You are now equipped with REX headlights and ready to get back on the road!



Disclaimer

REX Lighting is not liable for damages, injuries, or death while installing the product. The Installation Guide is intended as assistance to reduce installation time. REX Lighting assumes no responsibility for improper installation. If you are unfamiliar with your vehicle or inexperienced with aftermarket upgrades, please seek professional installation.